



## PALLET RACKING

**We have a variety of pallet racking options that will provide the perfect storage solution for your business.**

We take full consideration that each business needs to find a storage solution which makes the most of the available space.

We will evaluate the type of goods you store, the amount of floor space available for the racking installation, the speed of throughput and the type of equipment you use before recommending the best solution.

- **Adjustable pallet racking**
- **Push back pallet racking**
- **Pallet live racking**
- **External pallet racking**
- **Narrow aisle pallet racking**
- **Drive-In pallet racking**



# The fully flexible warehouse solution



## Heights

Height (mm)  
2500, 3000,  
4000, 5000, 6000



## Widths

Widths (mm)  
1350, 2225, 2700, 3300



## Depths

Depths (mm)  
900, 1100



## Application

Environment  
**Warehouse**

Usage  
**Multipurpose Storage,  
Heavy & Bulky Items,  
Palletised Goods**



## Construction

Frames: **Steel**  
Galvanised

Beams: **Steel**  
RAL 1003 Yellow

Please contact the Sales  
Team for accessory  
construction details



## Loadings

Beam UDL (per pair)  
**Up to 3790kg**



# Choose your pallet and frame size

## UK Pallet

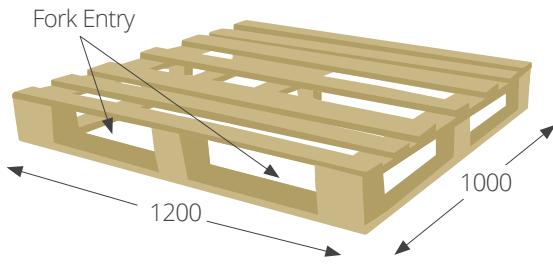

## Frame

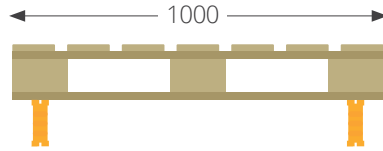

Use 900mm frames

## Euro Pallet

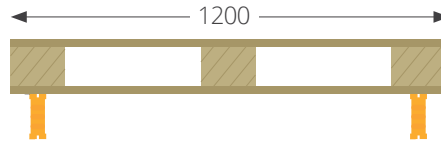
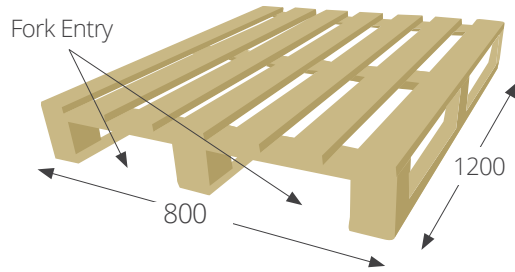

Use 1100mm frames

## Design your layout

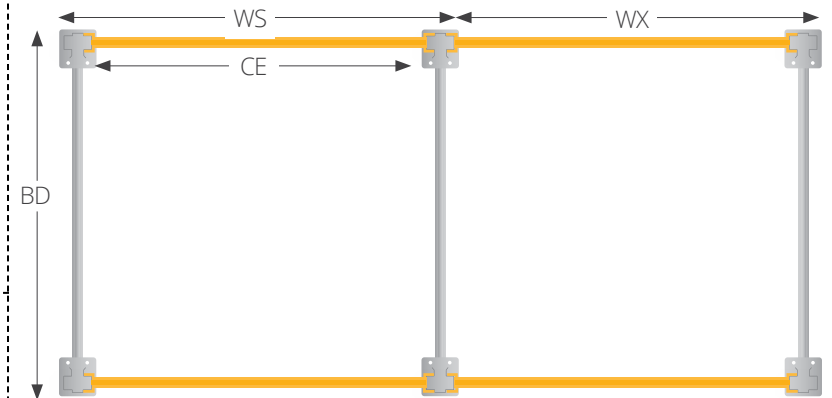

Nominal Depth (D)	BD Bay Depth	Nominal Width (W)	CE Clear Entry	WS Starter Bay	WX Extension Bay
900mm	920mm	1350mm	1313mm	1555mm	1456mm
1100mm	1120mm	2225mm	2183mm	2425mm	2326mm
		2700mm	2663mm	2905mm	2806mm
		3300mm	3263mm	3505mm	3406mm

Baseplate allowance for frame depth = 15mm, Baseplate allowance for entire row length = 31mm

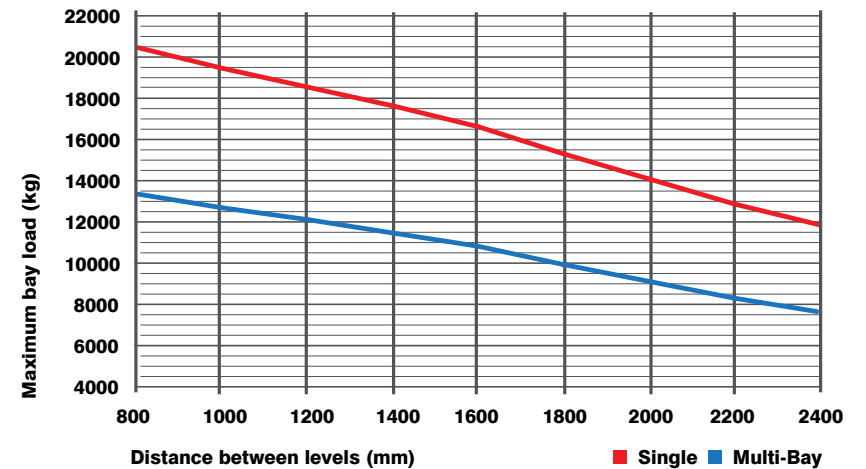
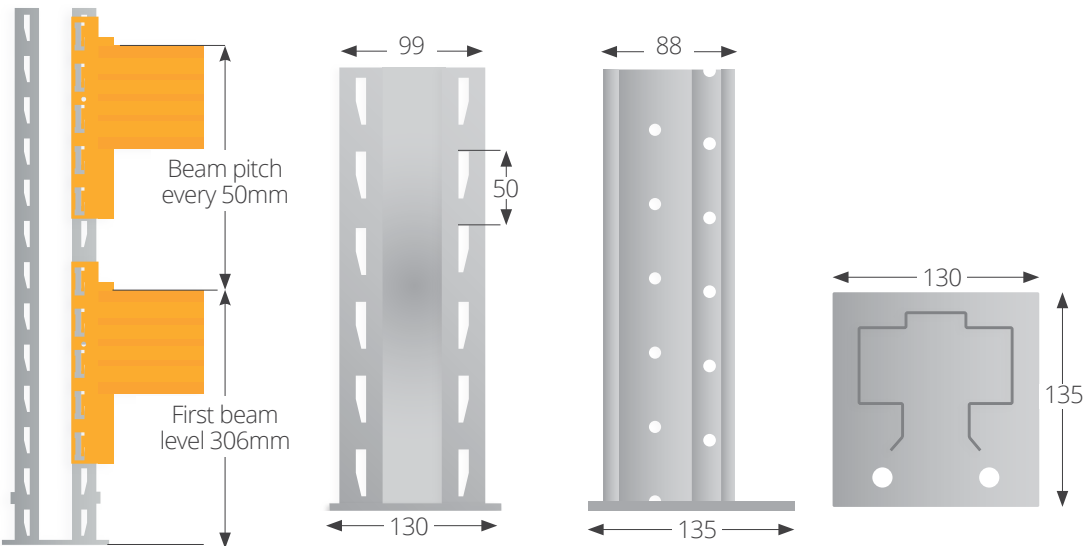

Frame capacity is calculated at a beam pitch of 1500mm, and a run of five 2700mm wide bays

If you don't see a solution that meets your requirement, then please get in touch.

Now available in frames up to 6000mm high



Frames				
Depth - 900mm			Depth - 1100mm	
H (mm)	Code	Price	Code	Price
2500mm	MPRF/2509/GV	<b>£190.04</b>	MPRF/2511/GV	<b>£198.89</b>
3000mm	MPRF/3009/GV	<b>£217.07</b>	MPRF/3011/GV	<b>£227.27</b>
4000mm	MPRF/4009/GV	<b>£266.13</b>	MPRF/4011/GV	<b>£277.48</b>
5000mm	MPRF/5009/GV	<b>£315.19</b>	MPRF/5011/GV	<b>£327.69</b>
6000mm	MPRF/6009/GV	<b>£377.40</b>	MPRF/6011/GV	<b>£393.55</b>

Beams				
W (mm)	Code	Beam Profile (mm)	Load Per pair (kg)	Price Per Pair
1350	MPRB/1375/YW	75	3540	<b>£87.90</b>
2225	MPRB/2210/YW	100	2800	<b>£146.10</b>
2700	MPRB/2712/YW	125	3180	<b>£189.50</b>
3300 (900mm Deep)	MPRB/331709/YW	175	3790	<b>£310.70</b>
3300 (1100mm Deep)	MPRB/331711/YW	175	3790	<b>£310.70</b>

<sup>①</sup> Price includes uprights, metal feet and all necessary bracing, and fixings (including throughbolts).  
<sup>†</sup>Frame capacity is calculated at a beam pitch of 1500mm, and a run of five 2700mm wide bays.



U-Shaped Upright Protector



L-Shaped Upright Protector



Visiplas (500mm High)

Accessories		
Description	Code	Price
Upright Protector Type L - 400mm	RPS/CCG4004	<b>£55.20</b>
Upright Protector Type U - 400mm	RPS/UCG4004	<b>£67.15</b>
Visiplas Upright Protector 79-92mm	AVB	<b>£20.85</b>
Visiplas Upright Protector 92-105mm	AVC	<b>£21.60</b>
200mm Row Spacer	MPPRS/20/GV	<b>£6.00</b>
250mm Row Spacer	MPPRS/25/GV	<b>£7.15</b>
Shim 1.0mm	MPR01/SHIM10	<b>£2.05</b>
Floor Fixing M12 x 100	FFM12X100	<b>£2.00</b>

<sup>①</sup> Need help designing your layout or costing a project, just give us a call.



# Optimise your warehouse with Pallet Racking accessories

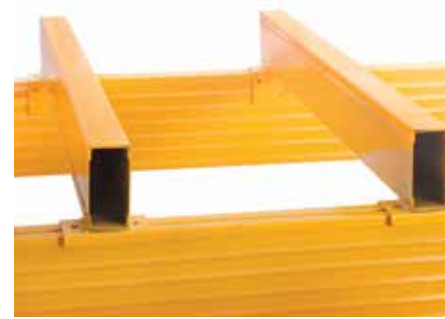

Fork Spacers

D (mm)	Load (kgs)	Code	Price
900 (Pair)	2000 (Pair)	MPRFS/09/YW	<b>£95.70</b>
1100 (Pair)	2000 (Pair)	MPRFS/11/YW	<b>£106.60</b>



Pallet Support Bars

D (mm)	Load (kgs)	Code	Price
900 (Pair)	1700 (Pair)	MPRSP/09/GV	<b>£38.50</b>
1100 (Pair)	1500 (Pair)	MPRSP/11/GV	<b>£44.10</b>

Open Timber Decking

W x D (mm)	Load (kgs)	Code	Price
1350 x 900	500	MPROTD/1309	<b>£41.85</b>
2225 x 900	810	MPROTD/2209	<b>£72.20</b>
2700 x 900	1000	MPROTD/2709	<b>£83.70</b>
3300 x 900	1226	MPROTD/3309	<b>£108.30</b>
1350 x 1100	685	MPROTD/1311	<b>£52.65</b>
2225 x 1100	1120	MPROTD/2211	<b>£91.30</b>
2700 x 1100	1375	MPROTD/2711	<b>£105.30</b>
3300 x 1100	1680	MPROTD/3311	<b>£136.95</b>

Wire Decking Panels

W x D (mm)	Load (kgs)	Code	Price
1350 x 900	1000	MPRMWD/1309	<b>£48.70</b>
2700 x 900	2000	MPRMWD/2709	<b>£97.40</b>
1350 x 1100	1000	MPRMWD/1311	<b>£57.90</b>
2225 x 1100	2000	MPRMWD/2211	<b>£94.50</b>
2700 x 1100	2000	MPRMWD/2711	<b>£115.80</b>
3300 x 1100	3000	MPRMWD/3311	<b>£141.75</b>

① Standard pallet loads are 1000kgs for minimum 800mm deep pallets on 900mm deep pallet racking  
Standard pallet loads are 1000kgs for minimum 1000mm deep pallets on 1100mm deep pallet racking



① If you don't see a solution that meets your requirement, then please get in touch.

# Choose your Pallet Racking Kit

 **900 Kits**  
For use with UK Pallets (1200 x 1000)

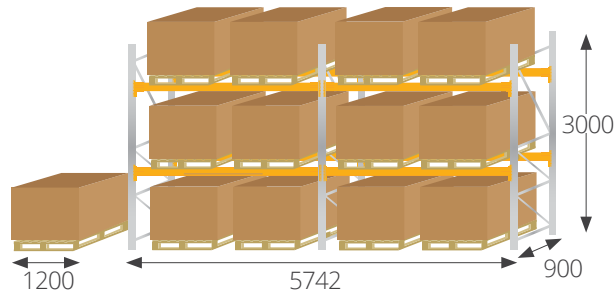

○ Pallet Racking Kit 1 for 12 x pallets (Boxes shown H: 1000 x W: 1200mm)

### Pallet Racking Kit 1

H x W x D (mm)	Code	Levels	Pallets Stored	Price
3000 x 5742 x 900	MPRK1	2	12	<b>£1,431.71</b>

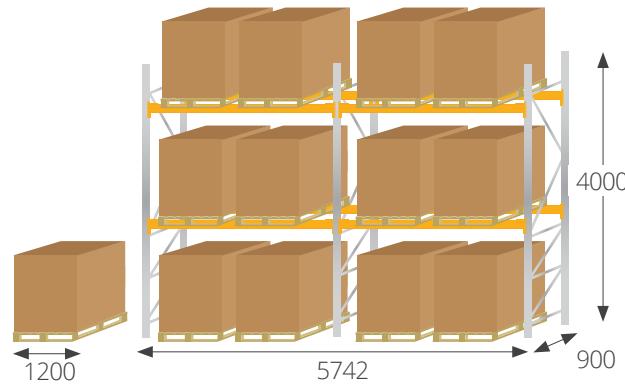

○ Pallet Racking Kit 2 for 12 x pallets (Boxes shown H: 1500 x W: 1200mm)

### Pallet Racking Kit 2

H x W x D (mm)	Code	Levels	Pallets Stored	Price
4000 x 5742 x 900	MPRK2	2	12	<b>£1,578.89</b>

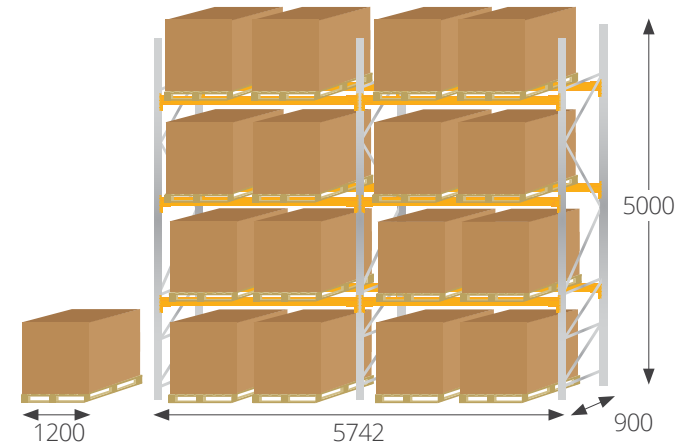

○ Pallet Racking Kit 3 for 16 x pallets (Boxes shown H: 1200 x W: 1200mm)

### Pallet Racking Kit 3

H x W x D (mm)	Code	Levels	Pallets Stored	Price
5000 x 5742 x 900	MPRK3	3	16	<b>£2,105.07</b>

 **1100 Kits**  
For use with Euro Pallets (800 x 1200)

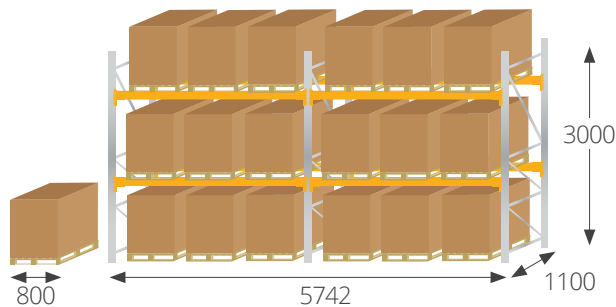

○ Pallet Racking Kit 4 for 18 x pallets (Boxes shown H: 1000 x W: 800mm)

### Pallet Racking Kit 4

H x W x D (mm)	Code	Levels	Pallets Stored	Price
3000 x 5742 x 1100	MPRK4	2	18	<b>£1,462.31</b>

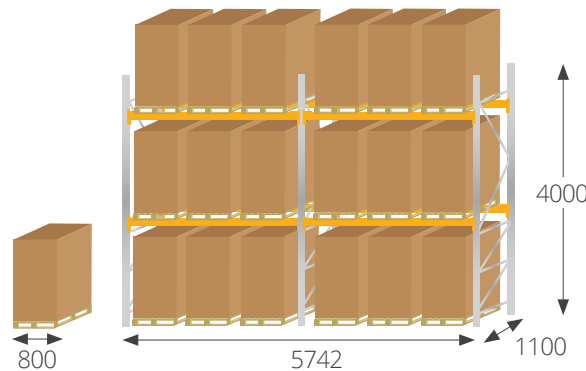

○ Pallet Racking Kit 5 for 18 x pallets (Boxes shown H: 1500 x W: 800mm)

### Pallet Racking Kit 5

H x W x D (mm)	Code	Levels	Pallets Stored	Price
4000 x 5742 x 1100	MPRK5	2	18	<b>£1,612.94</b>

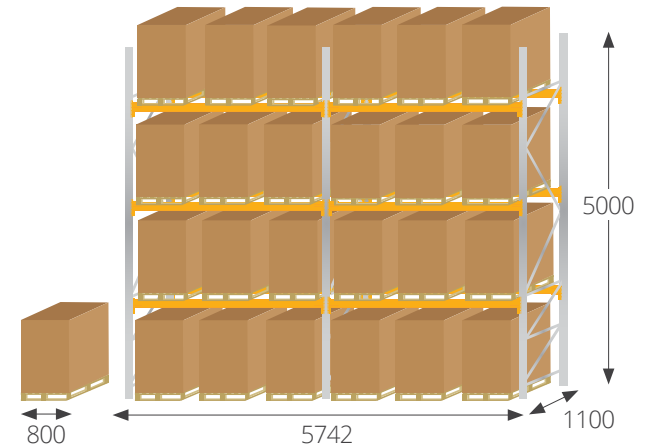

○ Pallet Racking Kit 6 for 24 x pallets (Boxes shown H: 1200 x W: 800mm)

### Pallet Racking Kit 6

H x W x D (mm)	Code	Levels	Pallets Stored	Price
5000 x 5742 x 1100	MPRK6	3	24	<b>£2,142.57</b>

ⓘ Each kit includes one starter bay and one extension bay. The beams are 2700mm long. Loading capacity is 3180kgs per level. Each kit includes frames, beams, locking pims, levelling shims and floor fixings.

ⓘ **We offer other Pallet Racking configurations. Give us a call to see how we can accommodate your warehouse requirements.**





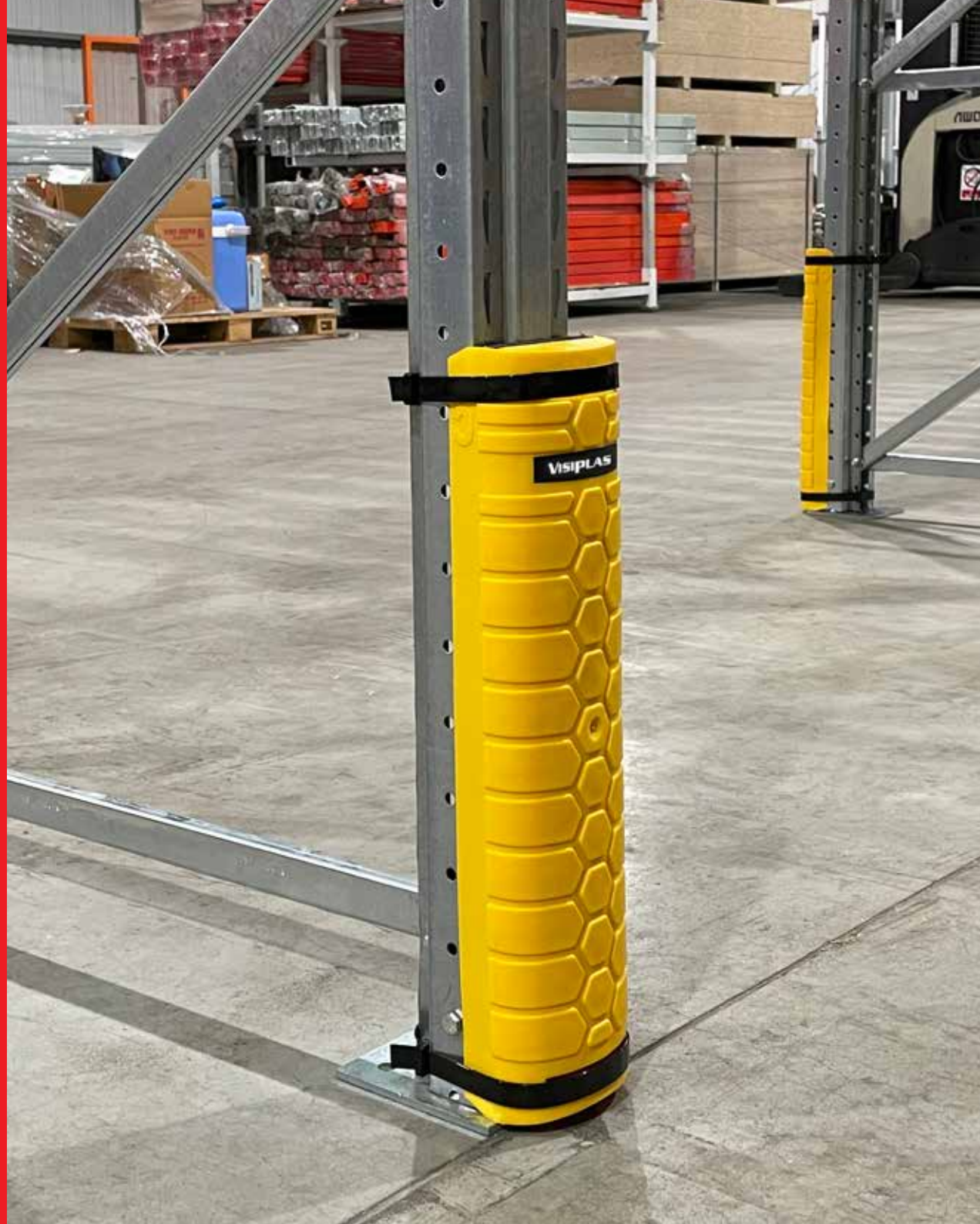

## UPRIGHT RACK PROTECTORS

Our moulded rack protectors offer a high visibility bumper, which suits many of the leading pallet racking systems.

Ideally suited for intermediate uprights with a slim profile that does not reduce the clear opening of the bay.

The unique design allows the impact to be absorbed within the protector whilst having the ability to reform after impact. Each guard is quickly installed onto the face of the upright with two cable ties (an additional cable tie is supplied for every protector for maintenance)

- **Cost effective pallet rack protector**
- **Tough impact resistant**
- **High visibility yellow**
- **Energy absorbing design**
- **Easily fitted and removed**
- **Certified to impact loads specified in EN15512-2009**
- **Made from polyethylene compounded plastic**







**Heights**

Height (mm)  
**500**



**Widths**

Widths (mm)  
**50 - 63mm**  
**79 - 92mm**  
**92 - 105mm**



**Depths**

Depths (mm)  
**44**



**Application**

Environment  
**Warehouse**  
**Workshop**  
**Storeroom**



**Construction**

Plastic:  
**Polyethylene**  
**compounded**  
**plastic**



**Loadings**

**Certified to**  
**impact loads**  
**specified in**  
**EN15512-2009**



# Choose your upright protector size



AVSI = 50 - 63mm  
 AVB = 79-92mm  
 AVC = 92-105mm

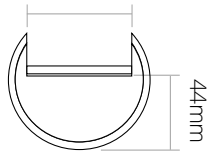

Description	Code	Upright Width	Height	Colour	Price
Visiplas Upright Protector	AVS1	50-63mm	500mm	Yellow	<b>£19.30</b>
Visiplas Upright Protector	AVB	79-92mm	500mm	Yellow	<b>£20.85</b>
Visiplas Upright Protector	AVC	92-105mm	500mm	Yellow	<b>£21.60</b>
Visiplas Cable Tie	AVQ	600mm	-	Yellow	<b>£1.10</b>

① Each protector comes with 3 cable ties. Two cable ties required for each protector. Additional cable ties can be ordered separately. Size : 610mm (W) X 16mm (H) Made from Nylon plastic.

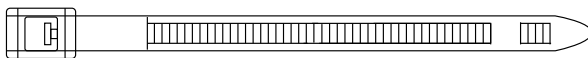

Quick Release & Re-Usable Cable Tie

- Absorbs the impact energy preventing damage to the upright
- Available in several widths to suit different manufacturers' uprights
- Protectors are 500mm high and can be stacked two high (1000mm)
- Simple attachment to the rack uprights with 2 cable ties
- Quick release cable tie for easier maintenance checks
- Narrow design without reducing the clear entry of the bay
- High visibility yellow colour enhances position of upright location
- Injection moulded from a high impact plastic compound
- Distributes the collision load to an internal energy absorbing pad
- Chemical resistant and suitable for use in temperatures down to -35°C
- Design Registration No. 335225 and No. 335226

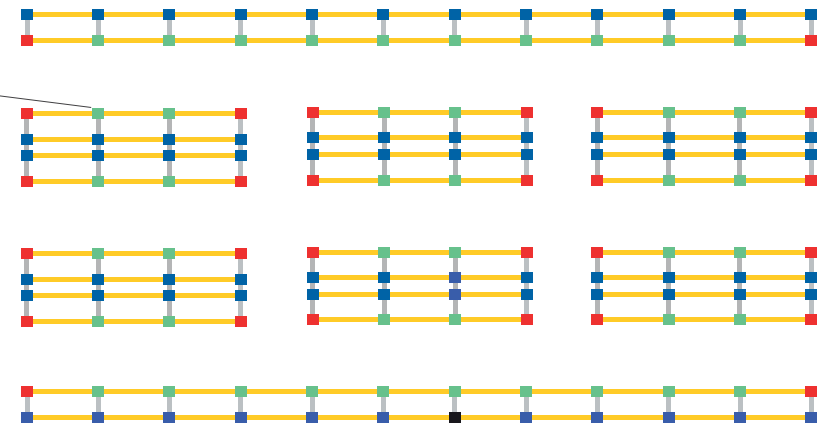

■ Intermediate uprights  
 Visiplas Protector  
 ■ Corner uprights  
 (Steel Protectors)

① Our moulded rack protectors offer a high visibility bumper, which suits many of the leading pallet racking systems.

## Corner Protector (Steel)



Size H x W x D	Code	Colour	Price
400x200x200mm	RPS/CCG4004	Yellow (RAL1003)	<b>£55.20</b>

## Narrow Aisle Guard (Steel)



Size H x W x D	Code	Colour	Price
400x160x280	RPS/UCG4004	Yellow (RAL1003)	<b>£67.15</b>

## Rack Protection Barriers

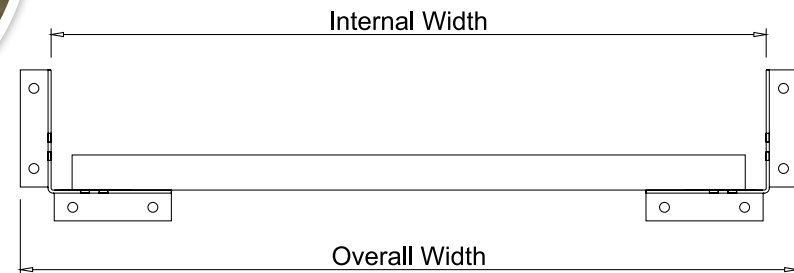

### Floor Fixing



FFM12x100 M12x100 **£2.00**

Size W x H	Code	Overall Width	Internal Width	Colour	Price
1060x400mm	RPS/BRSET1060	1060-1110mm	960-1010mm	Yellow/Galv	<b>£151.85</b>
1260x400mm	RPS/BRSET1260	1260-1310mm	1160-1210mm	Yellow/Galv	<b>£164.10</b>
2230x400mm	RPS/BRSET2230	2210-2260mm	2110-2160mm	Yellow/Galv	<b>£221.20</b>
2480x400mm	RPS/BRSET2480	2460-2510mm	2360-2410mm	Yellow/Galv	<b>£236.15</b>
2560x400mm	RPS/BRSET2560	2610-2660mm	2510-2560mm	Yellow/Galv	<b>£245.10</b>

**i** Ideally suited for intermediate uprights with a slim profile that does not reduce the clear opening of the bay.





# Let us design your Barrier Protection layout

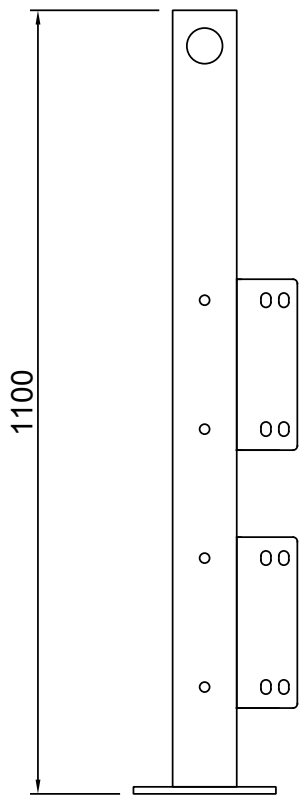

Double Barrier/Handrail

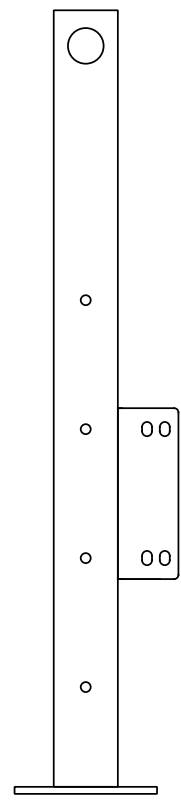

Single Barrier/Handrail

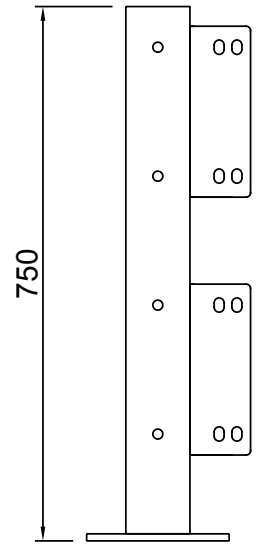

Double Barrier

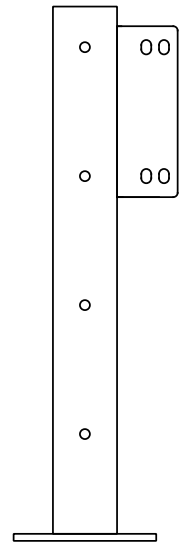

Single Barrier

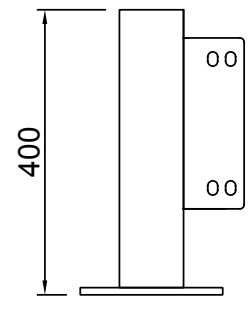

Single Barrier

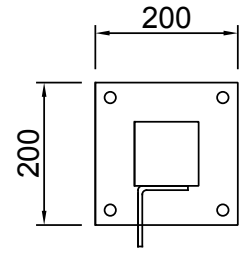

1 Way

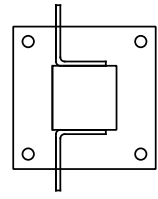

2 Way inline

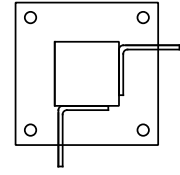

2 Way Angled

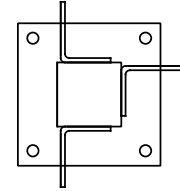

3 Way

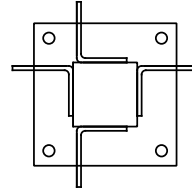

4 Way



Our moulded rack protectors offer a high visibility bumper, which suits many of the leading pallet racking systems.

# Choose your Sigma Barrier

Our barrier protection system is designed to be solid and sturdy, whilst offering complete flexibility in design and layout.

Available in three heights, with the 1100mm high complete with a handrail at the top. The base rail uses a sturdy Sigma beam profile, which is then connected to the posts, by two styles of brackets, keeping everything quick and easy to design and install.



Sigma Barrier	Code	Price
900mm	RPS/GR0900/KT	£53.85
1100mm	RPS/GR1100/KT	£66.10
1950mm	RPS/GR1950/KT	£123.20
2050mm	RPS/GR2050/KT	£123.20
2300mm	RPS/GR2300/KT	£138.15
2450mm	RPS/GR2450/KT	£147.10
Handrail	Code	Price
1950mm	RPS/HR19/KT	£64.65

Barrier Posts	Code	1 Way	Code	2 Way Straight	Code	2 Way Corner	Code	3 Way	Code	4 Way
400mm (single)	RPS/IP400S/1W	£103.65	RPS/IP400S/2WS	£125.80	RPS/IP400S/2WC	£122.45	RPS/IP400S/3W	£144.60	RPS/IP400S/4W	£163.40
750mm (single)	RPS/IP750S/1W	£128.30	RPS/IP750S/2WS	£150.45	RPS/IP750S/2WC	£147.10	RPS/IP750S/3W	£169.25	RPS/IP750S/4W	£188.05
750mm (double)	RPS/IP750D/1W	£153.95	RPS/IP750D/2WS	£198.25	RPS/IP750D/2WC	£191.55	RPS/IP750D/3W	£235.85	RPS/IP750D/4W	£273.45
1100mm (single)	RPS/IP1100S/1W	£148.35	RPS/IP1100S/2WS	£170.50	RPS/IP1100S/2WC	£167.15	RPS/IP1100S/3W	£189.30	RPS/IP1100S/4W	£208.10
1100mm (double)	RPS/IP1100D/1W	£174.00	RPS/IP1100D/2WS	£218.30	RPS/IP1100D/2WC	£211.60	RPS/IP1100D/3W	£255.90	RPS/IP1100D/4W	£293.50

**i** Ideally suited for intermediate uprights with a slim profile that does not reduce the clear opening of the bay.